

Welcome to the Pulsar family!

You are now the proud owner of India's No.1 sports bike. By No.1 we are talking about unparalleled performance, superior technology and incredible market leadership that Pulsar today enjoys. This makes the Pulsar you ride, unbeatable and unchallenged both on and off the road.

Before you ride out, please read this Owner's Manual carefully and familiarize yourself with the operating mechanism, controls and maintenance requirements of your Pulsar. This will ensure you a safe and trouble free ownership experience.

To keep your bike in perfect running condition and deliver consistent performance, we have specially programmed the periodic maintenance services which includes 3 Free and subsequent Paid services, as per the schedule contained in this booklet. We earnestly advise you to avail all these services at any of our Bajaj Dealers or Authorised Service Centres, who are well equipped with all necessary facilities / genuine parts / oil and trained manpower to ensure the best care for your Pulsar. Your **Pulsar** comes with a warranty of 2 Years or 30,000 Kms whichever occurs earlier from the date of sale. For details please refer to "Warranty : Scope & Limits" given in this manual.

Should you require any additional information feel free to contact us on our toll free no.:

**1800 233 2453** or e-mail us at: **customerservice@bajajauto.co.in** or visit the Bajaj Auto website [www.bajajauto.com](http://www.bajajauto.com)

To be a part of the Pulsarmania, visit [www.mypulsar.com](http://www.mypulsar.com) and join the Pulsar fanpage on facebook: [www.facebook.com/mypulsar](https://www.facebook.com/mypulsar)

Rev up, shift gears and enjoy the Pulsar experience...

**SERVICE DEPARTMENT**  
**BAJAJ AUTO LIMITED**

# Table of Contents

**pulsar** *125*-*1*  
**220**

## Description

1. Technical Specifications	1
2. Identification Data	3
3. Location of Parts	4
4. Steering cum Ignition lock / Important Icons	5
5. Fuel Tank Cap / Fuel Tap	6
6. Speedometer Details	7
7. Control Switches	8
8. Removal & Fitment of Side Covers	10
9. Removal & Fitment Seat	11
10. Battery / Tool kit	12
11. Daily Safety Checks	13
12. How to ride your Bike	14
13. Safe Riding Tips	18
14. Engine Oil	19
15. Wheels - Tyre	20
16. Periodic Maintenance Information	21
17. Free Service Guidelines	25
18. Periodic Maintenance & Lubrication Chart	26
19. Non Use Maintenance	31
20. Delivery Certificate	33
21. Warranty Scope & Limit	34
22. Battery Warranty Card	

## Safety and Warning information :



**Warning :** This indicates that a potential hazard or injury to you or other persons & to the vehicle can happen if advice provided is not followed.



**Caution :** This indicates that a potential hazard that could result in vehicle damage. Follow the Advice provided with the caution.

## Notice:

The description and illustration in this booklet are not to be taken as binding on the manufacturers. The essential features of the type described and illustrated herein remaining unaltered. Bajaj Auto Limited reserves the right to carry out at any moment without being obliged to bring this booklet upto-date & to do modifications on the vehicle, parts or accessories as may be convenient and necessary.

## Technical Specifications

*pulsar* **DTS-I**  
**220**

Engine	: 4 Stroke, Oil cooled
Bore x Stroke	: 67.00mm x 62.4mm
Eng. Displacement	: 220 cc
Compression Ratio	: 9.5 +/- 0.5 : 1
Idling Speed	: 1400 ± 100
Max. Net Power	: 20.93 PS at 8500 RPM
Max. Net Torque	: 18.55 Nm at 7000 RPM
Ignition System	: DC CDI
Spark Plug (2 Nos.):	Champion RG6HCC
Spark Plug Gap	: 0.7 to 0.8 mm
Lubrication	: Wet sump, Forced
Transmission	: 5 speed constant mesh
Gear Shifting	: 1 Down 4 Up
Brakes (Fr. & Rr.)	: Hydraulic operated disc brakes
Starting Aid	: Electric Starter

Fuel Tank Capacity :	
Full	: 15.0 liters
Reserve	: 3.2 liters
Usable Reserve	: 2.0 liters
Tubeless Tyre Size :	
Front	: 90/90 x 17, 49P
Rear	: 120/80 x 17, 61P
Tyre Pressure :	
Front	: 2 kg/cm <sup>2</sup> (28.4 PSI)
Rear (solo)	: 2.1 kg/cm <sup>2</sup> (30 PSI)
Rear (pillion)	: 2.25 kg/cm <sup>2</sup> (32 PSI)
Dimensions :	
Length	: 2035 mm
Width	: 750 mm
Height	: 1165 mm
Wheel base	: 1350 mm
Ground Clearance	: 165 mm

## Technical Specifications

**pulsar** *125i*  
**220**

Electrical System	: 12 Volts DC
Battery	: 12V - 9 Ah
<b>Head Lamp</b>	: 55W (Low Beam) : 55W (High Beam)
Pilot Lamp	: 5W (2 Nos)
Tail /Stop	: LED
Side Indicator	: 10W (4 nos)
Neutral Indicator	: LED
Hi Beam Indicator	: LED
Turn Pilot Indicator	: LED
Side Stand Indi.	: LED
Speedometer	: LCD Display
Rear No. Plate	: 5W
Horn	: 12V DC (2 Nos.)
Kerb Weight	: 155 kg
Gross Weight	: 285 kg

### **Note :**

- *All dimensions are under UNLADEN condition.*
- *Above information is subject to change without any notice.*
- *This vehicle complies to BS IV standards.*
- *AHO is government regulation.*

## Identification Data

*pulsar* DTS-I  
220

The Frame and Engine serial numbers are used to register the motorcycle. They are the unique alpha-numeric codes to identify your particular vehicle from others of the same model and type.



▼  
**Chassis Number Location**  
On Side of Steering Tube  
(Alpha-Numeric - 17 Digits)

### Engine Number Location

On LH Side Crankcase Near Gear  
Change Lever (Alpha-Numeric - 11 Digits)



## Location of Parts

*pulsar* **DT5-1**  
**220**

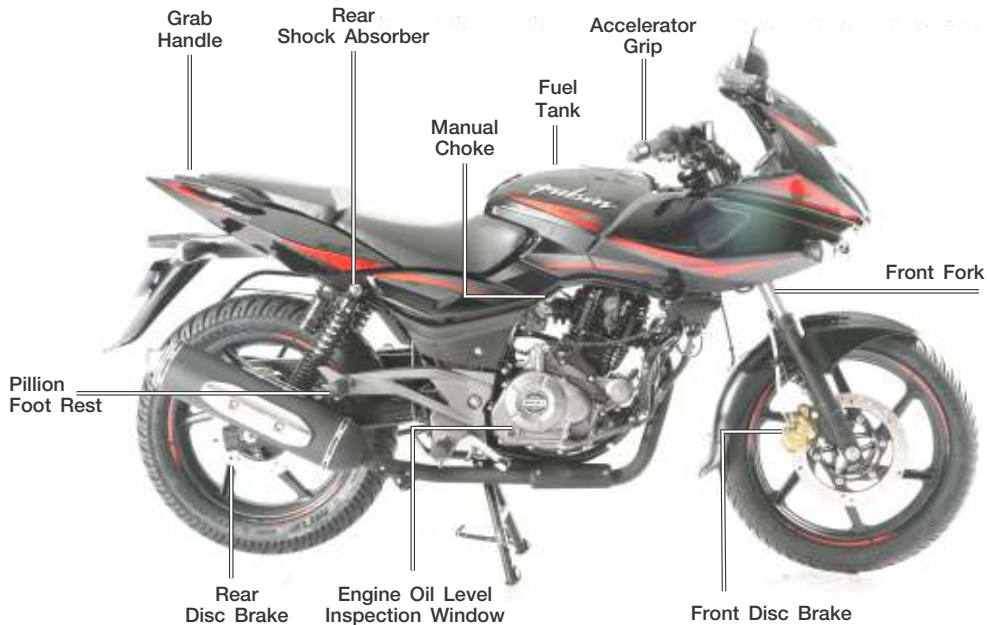



## Steering cum Ignition Lock :

**To Lock the Steering ( ● ) :** To lock the steering, turn the handle bar to the left or right. Push & release the key. Turn the key to “LOCK” position and remove the key.

**To Unlock the Steering ( ? ) :** To unlock steering, insert the key in steering cum ignition lock & turn it clockwise to “OFF” or “ON” ( ? ) position.

**Key :** A common key is used for ‘Steering cum Ignition lock’, ‘Fuel tank cap’ & ‘Side cover lock’.

## Icons On Speedo Display At The Top



Air Filter  
Choked



Low Engine  
Oil Level



High Engine  
Temperature



**These icons glow whenever their limits are exceeded.**

Take your vehicle to service station for maintenance of required item, if any of the above indicating icon glows continuously.

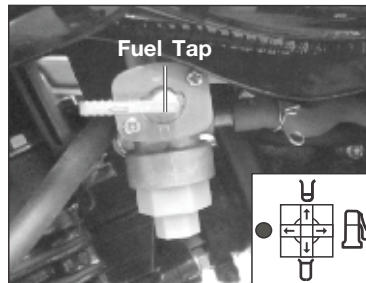

## Fuel Tank Cap

- To open the fuel tank cap, open the flap. Insert the key in the lock and turn it clockwise and lift fuel tank cap.
- To lock the 'Fuel Tank Cap' insert the key in the lock and turn it clockwise and press fuel tank cap. 'Click' sound ensures cap is fully locked.

Precaution :

Dont attach metallic 'Key chain' as it may damage paint of petrol tank.

## Fuel Tap

Fuel tap lever has following positions.

●	OFF : When fuel supply is to be cut off.
U	ON : When fuel level is above reserve position.
U	RES : When fuel level is below reserve position.





Speedometer display will get on when ignition switch is made 'ON'.

1. **Fuel level indicator** : Fuel level indicator shows approx available fuel in fuel tank.() Symbol blinks continuously when petrol level reaches reserve level.
2. **Tachometer** : It shows the engine speed in RPM.
3. **Odometer** : The Odometer shows the total distance that the vehicle has accumulated.
4. **Turn signal indicator** : When ignition switch is 'ON' & turn signal switch is turned to LH/RH, Side indicator will flash.
5. **Neutral indicator** : When ignition switch is 'ON' & the transmission is in neutral, the neutral indicator light will glow.
6. **Side stand indicator** : When ignition switch is 'ON' & side stand is down, side stand indicator will glow.
7. **Speedometer** : The vehicle speed is displayed digitally in KM/HR.
8. **Trip meter knob** : Reset trip meter to zero by pressing the trip meter knob.
9. **Trip meter** : It shows the distance travelled since it was last reset to zero.
10. **Hi beam indicator** : When ignition switch is 'ON' & the H/L is on high beam, the hi beam indicator light will glow.
11. **Low Battery Indicator** : It indicates battery needs charging.

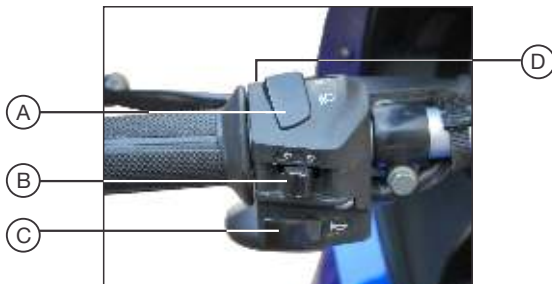

### Left Handle Bar Switches

**A. Dipper Switch :** When headlight is ON, High or Low beam can be selected with the dipper switch.

☰ : High Beam      ☷ : Low beam

**B. Turn Signal Switch :** When the turn signal knob is turned to Left (↶) or Right (↷) the corresponding turn signals start flashing. To stop flashing, push the switch in & release.

**C. Horn Button :** (  ) Press button for sounding horn.

**D. Pass Switch:** Press the switch to flash the head light. It is used to give signal to vehicles coming from opposite side while overtaking.

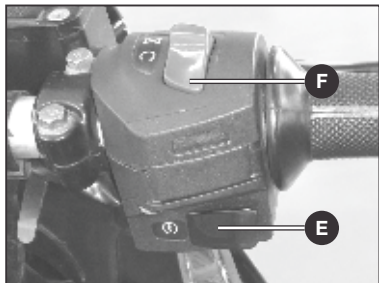

## Right Handle Bar Switches

### E. Starter Button :

Starter button operates the electric starter. It is recommended to start the engine with the transmission in neutral.

Vehicle in Gear - Press clutch lever & operate starter button to start the engine.

### F. Engine Kill Switch :

The engine kill switch is used for switching ON & OFF the engine.

 : Engine OFF

 : Engine ON



## AHO Feature (Automatic Headlight 'ON')

There is no 'Light switch' on RH control switch.

Ignition switch 'ON' Engine 'OFF'	Speedometer illumination Tail lamp, Number Plate Lamp, Pilot Lamp & Control Switches Illumination will get 'ON'
Effect of pressing 'Pass Switch'	In addition to above Hi-beam will get 'ON'

## Ignition switch 'ON' & Engine Running

Speedometer illumination, Tail lamp, Number Plate Lamp, Pilot Lamp & Control Switches Illumination will get 'ON'  
in addition to above, headlamp will get on as given below.

Hi/Low beam Switch	Headlamp Status	Effect of Pass Switch
Low beam 	Low beam 'ON'	Low+Hi beam 'ON'
Hi beam 	Hi beam 'ON'	No change

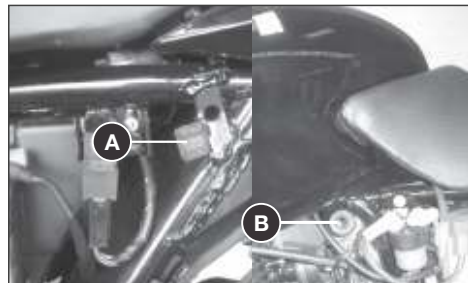

### Removal of Side Cover LH

- Access to battery is by removing LH cover.
- Insert ignition key (A) & turn it clock wise.
- Pullout the cover (B) from fuel tank knob.
- Slide the cover (C) towards left direction .
- Direction of removal is important to avoid breakage of cover locking lug.

 **CAUTION** : Remove cover as described above, Otherwise the lugs may break.

### Fitment of Side Cover LH

- Match slot provided on rear end of 'Side Cover' with bracket (A) provided on 'Chassis' and slide 'Side Cover' backward (towards Tail lamp).
- Match Lug provided on front portion of 'Side Cover' with hole (B) provided on 'Fuel Tank' and press 'Side Cover' inside.
- Match the lock plate of 'Side Cover' properly with bracket on 'Chassis' and rotate key in clockwise direction to lock.



Seat Release Cable

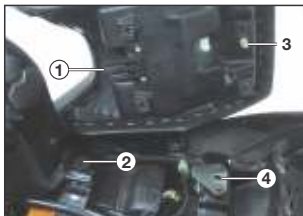

Fig. B



Fig. C

## Removal of Seat - Front & Rear

- Remove 'Side Cover' LH.
- To remove Seat Front, pull the 'Seat Release Cable' (A) to release seat lock. Keeping cable pulled, tap the center of seat, lift the seat from rear end & slide it back to remove seat.
- To remove Seat Rear, pull the 'Seat Release Cable' (B) to release seat lock. Keeping cable pulled, tap the center of seat, lift the seat from rear end and slide it towards tail lamp to remove seat.



**Caution :** Always remove Rear Seat first.

## Fitment of Seat - Front & Rear

- For fitment of Seat Front, match & insert the

bracket ('1' of Fig. 'B'), of seat with slot ('2' of Fig. 'B') provided below fuel tank rear mounting on chassis. Push seat towards fuel tank and align lock rod ('3' of Fig. 'B') & seat lock ('4' of Fig. 'B'). Then press the seat in middle from top to lock the seat.

- For fitment of Seat Rear, match & insert the bracket ('5' of Fig. 'C') of seat with slot ('6' of Fig. 'C') provided below fuel tank rear mounting on chassis. Push seat towards fuel tank and align lock rod ('7' of Fig. 'C') & seat lock ('8' of Fig. 'C'). Then press the seat in middle from top to lock the seat.



**Caution :** Always fit Front Seat first.



### Battery (12V - 9Ah)

- Battery is located inside LH side cover.
- Make of battery may differ from vehicle to vehicle.



### Tool Kit Location

- It is located below Rear seat.
- Tool kit to be tight by 2 nos rubber bands.

### First Aid Kit Location

- First aid kit is to be stored in seat cowl.



**CAUTION** : Ensure tool kit is fitted properly with rubber bands.

Before riding motorcycle be sure to check following items. Please give proper importance to these checks and perform all of them before riding motorcycle.

If any irregularities are found during these checks, refer to the Maintenance chapter & see your dealer for the action required to return the motorcycle to a safe operating condition.



**Warning :** Failure to perform these checks every day before you ride may result in serious damage or severe accident.

- Enough **fuel level** for planned distance of journey. No fuel leakage in fuel lines.
- **Engine oil** level (between upper and lower level mark)
- **Throttle cable** play of 2 ~ 3 mm. Smooth operation and positive return to closed position,
- **Brake Pedal** Play - 20 to 30 mm.
- **Wear lining Indicator** within usable range. No brake dragging, applicable to drum brake vehicles.
- **Brake Fluid** level above MIN mark provided on reservoir, applicable to disc brake vehicle.
- **Drive Chain** slack of 25 to 30 mm adequately lubricated.
- Function of all **lights & horn**
- **Clutch lever** play - 2 to 3 mm
- Smooth **steering movement** without restriction.
- Both **stand** return to their fully up position.
- Correct **inflation pressure** in both tyres  
Adequate tyre tread depth - no cracks / cuts.
- Correct **rear viewing** span adjustment of mirror.

## Starting The Engine :

- Turn the fuel tap knob to 'ON' or 'RES' position.
- Switch 'ON' ignition & 'Kill Switch'
- Confirm that transmission is in neutral.
- Keep throttle completely closed, press starter button "Ⓢ" to start the engine.
- Release starter button as soon as engine starts.

**Note :** Do not let the engine idle longer than 3 minuets otherwise it will overheat.

- If the engine is cold or when starting for first time, use choke 'I' for quick starting.

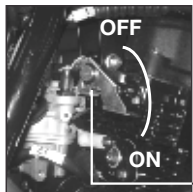

- When the engine is warmed up enough to idle without using choke, return the choke to OFF position.

**Manual Choke**

Referance photo



**Caution :** Do not operate the starter continuously for more than 5 seconds otherwise battery would get discharged. Wait 15 sec. between each operation of the starter which will facilitate battery to recover.

**Note :** The motorcycle is equipped with a clutch switch. This switch ensures that engine does not start if the transmission is in gear.

However, the engine can be started in any gear if the clutch lever is pressed.

## Moving Off :

- Check that Center/Side stand is up.
- Depress the clutch lever.
- Shift into 1<sup>st</sup> gear.
- Open the throttle and release the clutch lever slowly and simultaneously.
- As the clutch starts to engage, open the throttle a little more, giving the engine just enough rpm to keep it from stalling.



## Shifting Gears :

- Close throttle & depress the clutch.
- Shift into next higher or lower gear.
- Open the throttle and release the clutch lever slowly and simultaneously.



**Gear Shifting Lever**



**Gear Shifting Pattern**

## Recommended Speed for Shifting Down

From 5 <sup>th</sup> to 4 <sup>th</sup> Gear	50 km/h
From 4 <sup>th</sup> to 3 <sup>rd</sup> Gear	40 km/h
From 3 <sup>rd</sup> to 2 <sup>nd</sup> Gear	30 km/h
From 2 <sup>nd</sup> to 1 <sup>st</sup> Gear	20 km/h



**Warning :** When shifting down to lower gear, do not shift at such high speed that engine RPM jumps excessively. This may cause engine damage, & rear wheel may skid. Downshifting should be done at recommended speeds as shown in table.

## Braking :

- Close the throttle completely, leaving the clutch engaged (except where shifting gears) so that the engine braking will help slow down the motorcycle.
- Shift down one gear at a time so that you are in Neutral when you come to a complete stop.
- When stopping, always apply both brakes at the same time. De-clutch as necessary to avoid engine stalling.
- Never lock the brakes, or it will cause the tyres to skid. When cornering, use brakes judiciously & do not de-clutch. Reduce your speed before you get into the corner. For emergency braking, disregard downshifting, and concentrate on applying brakes as hard as possible without skidding.

## Stopping the Vehicle :

- Close the throttle completely.
- Shift the transmission into neutral.
- Bring the vehicle to complete stop.
- Turn the ignition switch off.

## Parking the Vehicle :

- Support the motorcycle on a firm level surface with the center or side stand.
- Lock the steering.

 **CAUTION** : Do not park on a soft or steeply inclined surface or the motorcycle may fall over.

**Whenever vehicle is falls down, remove plug of 'Y connector drain tube' & drain out accumulated petrol**



## Running IN

Proper running-in is important for the better life & trouble free performance of the vehicle.

- During first 2000 kms running-in period do not exceed following speed limits.

Kms	1st	2nd	3rd	4th	5th
0 - 1000	15	30	45	55	65
1000 - 2000	20	40	55	65	75

- Always keep the speed below the limits mentioned in the table.
- Do not race the engine excessively.
- Do not start moving or race the engine immediately after starting. Run the engine for a minute at idle speed to give the oil a chance to workup into the engine.

## Fuel Saving Tips :

A well maintained vehicle and good driving can contribute a lot to the saving of petrol. Following are a few simple fuel saving tips.

## Good Riding Habits :

- Ride smoothly and steadily at an optimum driving speed of 40 to 50 Km/h
- Avoid harsh braking.
- Change the gear judiciously according to the speed and load requirement.
- Don't overload the vehicle above the specified payload.
- Use the accelerator judiciously.
- Cut off the engine if you want to stop for more than two minutes.

## How to check mileage (Fuel efficiency)

Best way to calculate mileage is by following the full tank to full tank method.

- Fill way tank full up to small mouth (brim).
- Run the bike for say 100 km.
- Fill the tank full again in same fuel filling station, probably with same fuel dispenser.
- Divide kilometer run / fuel quantity filled.

Ensure following maintenance points to get optimum performance from your bike.

Fuel	Check fuel lines & connections for leakage.
Spark Plugs	Inspect and clean spark plugs. Adjust electrode gap. Replace spark plugs as per P.M. Chart.
Air Filter	Clean the air filter element periodically. Replace as per Periodic Maintenance Chart.
Engine Oil	Check engine oil level. Always use recommended grade and quantity.
Brakes	Ensure that the brakes are not dragging / binding.
Clutch	Ensure correct clutch lever play.
Tyre Air Pressure	Always maintain recommended tyre pressure.
Carburettor	Clean & adjust the carburettor. Adjust idling speed.

### Safe Riding Tips

- Always wear Helmet while driving or riding. Your helmet should conform to appropriate Indian standards.
- Read thoroughly the instructions given in this manual and follow them carefully.
- Avoid unnecessary accessories for the safety of both rider and other motorists.
- Get familiar and follow traffic rules & regulations in your states as well as general traffic signs.
- Familiarise yourself well with starting, acceleration and braking of the vehicle.
- When applying the brakes, use both front & rear brakes simultaneously. Applying only one brake may cause the vehicle to lose control.
- Riding at proper speed and avoiding unnecessary acceleration and braking are important not only for safety and low fuel consumption, but also for longer life of the vehicle.
- During monsoon drive the vehicle more cautiously. Remember vehicles skid more easily during light showers.



- Drive cautiously. Start early & reach your destination safely.
- Always carry vehicle registration & insurance papers, and a valid driving licence with you.
- Avoid driving on loose sand or stones where vehicle is likely to skid.
- Properly wrap-up loose clothes while driving or riding to avoid entangling in wheel or other objects on road.
- Always concentrate on riding for safety.

### Monsoon Care :

- It is suggested to customer to take appropriate care in area of heavy monsoon or high rainfall area. The appropriate surface preventive coat to avoid rusting / poor surface finish on account of adverse atmospheric conditions.
- Vehicle cleaning to be done with soft & clean wet cloth to avoid scratches on painted parts.
- Clean & lubricate all the important parts as detailed in a periodic maintenance chart.
- Do not apply direct water jet on painted, electrical / electronic parts.
- Do not obstruct engine cooling by adding mud protection sheet from front.

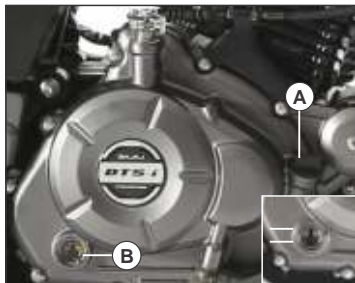

A: Oil Filler Cap, B: Oil Level Inspection Window

## Engine Oil Level Checking :

- Check engine oil level every day. Park vehicle on level surface.
- Check oil level through oil level gauge 'B'.
- Always maintain engine oil level between upper and lower mark provided on Cover RH. Top up with specified grade of oil if the oil level is below lower level mark.

## Engine Oil Capacity :

- Refill at servicing : 1150 ml.
- During engine overhaul : 1300 ml.

## Recommended Engine Oil:

Always insist on Bajaj Genuine Engine Oil for optimum engine performance and warranty benefits. It is a specially formulated oil for vehicles with DTS-i engines.



Recommended Engine oil	Grade
Bajaj DTS-i 10000	SAE 20W50 API 'SL'

- Engine oil replacement frequency : 1<sup>st</sup> service & then every 10,000 Km.
- Engine oil level top-up frequency : Every 5000 km.



## CAUTION :

- It is most important to adhere to recommended grade & frequency of oil change for the purpose of long life of critical engine components. For details refer periodic maintenance chart.
- Do not reuse drained oil.



### Tubeless Tyre :

The main advantage of tubeless tyres is in case of puncture the rate of air leak is very slow, hence customer can easily drive the vehicle upto nearest puncture repair shop for removing puncture.



**CAUTION :** Tubeless tyres are fitted in this motorcycle. The walls of the tyres in contact with the wheel rim should not be damaged in any way during fitment / removal of tyre. The tyre side walls in contact with wheel rim seals air.

### Wheel Puncture:

- Visit nearest known tubeless tyre repair shop to remove puncture.
- Remove puncture by Filler or Plug method only.
- Do not use patch method to remove puncture of tubeless tyre.

### Tyre Pressure :

Keep appropriate tyre pressure as mentioned below to increase life of the tyre & for better fuel consumption.

Pulsar 220	Front	28 PSI
	Rear (Solo)	28 PSI
	Rear (with Pillion)	32 PSI

**Note :** *Incase the motorcycle is fitted with imported tyres, compliance to respective indian standard & central motor vehicle rules has been ensured.*



### Front Brake Fluid Level :

- Front brake fluid master cylinder reservoir is located near RH switch on handle bar.
- To check oil level, keep vehicle on Center stand with handle bar in straight position.
- Always ensure that brake fluid level is above 'MIN' mark given on inspection window.
- Use only DOT 3 or DOT 4 brake fluid (from sealed container) to top up if required.

It is advisable that brake fluid should be replenished at every 30,000 Kms.



### Battery : 12V-9 Ah MF

- Battery is located inside 'Side Cover' LH.
- Always ensure that battery electrolyte level is in between max & min level marks.
- Check & top up battery by distilled water if electrolyte level is below min level mark.
- Battery life would get adversely affected if top up with 'Tap Water'.



**CAUTION :** Tap water is not a substitute for distilled water and will shorten the life of the battery.

- Environment care must be taken to dispose off the used battery. It is always recommended to hand over the same to the Authorised battery / Bajaj dealer for proper disposal of the same.
- When battery is found discharged, it is advised to get it charged immediately.

 **CAUTION :** Do not drive/run vehicle in battery disconnected condition. It may lead to damage of electrical /electronic components.

- Warranty on battery is 18 months from the date of purchase of vehicle.

### How to keep battery healthy ?

- Switch 'Off' ignition when engine is not running.
- Get battery checked / charged during periodic services.
- Do not press starter button for more than 5 sec. After 3 successive cranking, wait for 15-20 sec. for battery to recover.
- **Do not add extra electrical accessories such as - Remote, Bigger horn, Musical brake light etc. This will reduce life of battery**
- If vehicle is to be stored for more than 2 weeks disconnect battery to avoid self discharge.



### **CAUTION :**

- While disconnecting always disconnect negative (-ve) cable first.
- While refitting always connect positive (+ve) cable first.



### Spark Plug

- Remove spark plugs by using plug spanner.
- Clean the spark plugs.
- Adjust the gaps if incorrect by bending outer electrode carefully.

**Spark Plug Gap** : 0.7 to 0.8 mm.

**Spark Plug** (2 Nos.) : CHAMPION RG6HCC

### Drive Chain Slackness

- Chain slackness will have to be adjusted whenever required.
- Std. Chain slackness 25 ~ 30 mm.
- Marking on chain adjusters should be identically positioned on both sides.

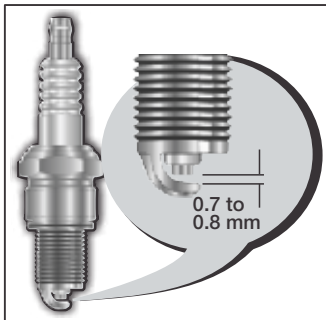



**Drive Chain**

Drive chain must be cleaned & lubricated as per periodic maintenance schedule.

### **Drive Chain (O-ring type)**

- 'O' rings must always be kept wet for best performance hence lubricate every 500 Km.
- **O-ring chain lubrication can easily be done by owners using Bajaj 'Chain Lube Spray Can' available with Bajaj dealers.**



**Chain Lube Spray**

### **Method of O-ring Chain Lubrication :**

- Park vehicle perpendicular to the ground on level surface. Clean the chain by using lint free cloth (If excessive mud / slush found approach Bajaj Service Center for proper cleaning)
- Shake the can vigorously by holding vertically upright till the noise of steel ball inside heard uniformly.
- Hold spray can at the back of rear sprocket with extension tube nose at 5~10 cm.
- Rotate the wheel in reverse direction & spray the lube on middle portion of the chain up to full length of the chain.

# Free Service Guidelines

Customer ID :

## Instruction to avail Free Service through Digitized Free Service Coupon

Please follow following procedure : -

- Please provide your mobile number to Dealer at the time of buying of new Bajaj Vehicle.
- In case of change in mobile number, please update to Dealer / ASC.
- You will receive the Customer ID through SMS at the time of buying of new vehicle.
- Please note the Customer ID in Owner's Manual for your reference.
- During Free Service, please provide your Customer ID to Dealer / ASC workshop.
- When you are at Dealership / ASC workshop for Free Service, you will receive the 'Unique Coupon Number' (UCN) through SMS in your mobile.
- Please inform the UCN to Dealer / ASC at the time of Free Service.

## Periodic Service Criteria

Service	Days	Kms	whichever occurs earlier
1st Free Service	30~45	500~750	
2nd Free Service	240	4500~5000	
3rd Free Service	360	9500~10000	
1st Paid Service			
2nd Paid Service	120 Days from last Service	Every 5000 Km after previous service	
3rd Paid Service			
4th Paid Service			

Availing all Free / Paid Services, replacing mandatory periodic parts & engine oil will entitle warranty eligibility.

# Periodic Maintenance & Lubrication Chart

Sr. No.	Operation	Servicing	RECOMMENDED FREQUENCY						Subsequent		
			Kms	1 <sup>st</sup> Free	2 <sup>nd</sup> Free	3 <sup>rd</sup> Free	Every				
				500 750	4500 5000	9500 10000	5000 Km after Previous Service				
1.	Water wash & dry the vehicle completely		<input checked="" type="checkbox"/>	<input checked="" type="checkbox"/>	<input checked="" type="checkbox"/>	<input checked="" type="checkbox"/>	<input checked="" type="checkbox"/>	<input checked="" type="checkbox"/>	<input checked="" type="checkbox"/>	Ensure to prevent water entry in Petrol tank, Silencer & electrical Parts. Use caustic free detergent for washing.	
2.	Engine oil (Bajaj DTSi 10000 oil)	C,R	<input type="checkbox"/> R	Top Up	<input type="checkbox"/> R	Top Up	<input type="checkbox"/> R	Top Up	<input type="checkbox"/> R	BGO DTSi 10W30 for 100cc models. BGO DTSi 20W50 for Models above 125cc.	
3.	Engine oil filter**	C,R	<input type="checkbox"/> R		<input type="checkbox"/> R		<input type="checkbox"/> R		<input type="checkbox"/> R		
4.	Oil strainer	CL	CL		CL		CL		CL		
5.	Body centrifugal filter**	CL	CL				CL		CL		
6.	Starter Clutch (Dry Type)**	L		L	L	L	L	L	L	Use recommended Molycote grease.	
7.	Spark plug	CL,A,R			CL,A		CL,A		<input type="checkbox"/> R		
8.	Air cleaner element ***	CL,R	CL	CL	CL	<input type="checkbox"/> R	CL	CL	<input type="checkbox"/> R		

✓ Tick in the box  after replacing the periodic parts.

# Periodic Maintenance & Lubrication Chart

**pulsar** *OTS-I*  
**220**

Sr. No.	Operation	Servicing Kms	RECOMMENDED FREQUENCY							Subsequent
			1 <sup>st</sup> Free	2 <sup>nd</sup> Free	3 <sup>rd</sup> Free	Every 5000 Km after Previous Service				
			500 750	4500 5000	9500 10000					
9.	Air filter cover 'O' ring	CL,R	CL	CL	CL	<input type="checkbox"/> R	CL	CL	<input type="checkbox"/> R	
10.	In line paper filter	R				<input type="checkbox"/> R			<input type="checkbox"/> R	
11.	Fuel cock paper filter.	R				<input type="checkbox"/> R			<input type="checkbox"/> R	
12.	Fuel cock sediment bowl cleaning	CL				CL			CL	
13.	Carburettor rubber duct	C,R					C,R			
14.	Fuel pipe	C,R	C	C	C	<input type="checkbox"/> R	C	C	<input type="checkbox"/> R	
15.	Valve tappet clearance	C,A			C,A		C,A		C,A	
16.	Non-Sealed drive chain cleaning & lubrication	CL,L,A	CL,L,A	CL,L,A	CL,L,A	CL,L,A	CL,L,A	CL,L,A	CL,L,A	
17.	Sealed drive chain cleaning & lubrication	CL,L,A	CL,L,A	CL,L,A	CL,L,A	CL,L,A	CL,L,A	CL,L,A	CL,L,A	Customer to apply OKS chain lub spray at every 500 kms.
18.	Engine air breather tube	C	C	C	C	C	C	C	C	
19.	Silencer drain hole cleaning	CL		CL	CL	CL	CL	CL	CL	

✓ Tick in the box  R after replacing the periodic parts.

# Periodic Maintenance & Lubrication Chart



Sr. No.	Operation	Servicing	RECOMMENDED FREQUENCY							Subsequent
			1 <sup>st</sup> Free	2 <sup>nd</sup> Free	3 <sup>rd</sup> Free	Every				
			500 750	4500 5000	9500 10000	5000 Km after Previous Service				
20.	Silencer tail pipe cleaning**	CL		CL	CL	CL	CL	CL	CL	
21.	Brake cam & brake pedal pivot pin	C,L,R	C	C,L,R	C,L,R	C,L,R	C,L,R	C,L,R	C,L,R	Use AP grease.
22.	Brake lining or pad - Check wear indicator		C,R	C,R	C,R	<input type="checkbox"/>	C,R	C,R	<input type="checkbox"/>	
23.	Brake fluid level **- top up / replace	C,A,R				C,A			<input type="checkbox"/>	Use recommended brake fluid (DOT3/DOT4)
24.	Disc brake assly -- Check functionality, leakage or any other damage.	C			C		C		C	
25.	All cables & rear brake pedal-free play	C,A	C,A	C,A	C,A	C,A	C,A	C,A	C,A	
26.	Battery electrolyte level, specific gravity	C,A	C,A	C,A	C,A	C,A	C,A	C,A	C,A	Not applicable for VRLA battery
27.	Wiring harness & Battery connections- routing, tie bands & clamps tightness.	C,A,T	C,A,T	C,A,T	C,A,T	C,A,T	C,A,T	C,A,T	C,A,T	
28.	Ignition switch barrel cleaning	C,CL	C,CL	C,CL	C,CL	C,CL	C,CL	C,CL	C,CL	Use WD40 spray

✓ Tick in the box  after replacing the periodic parts.

# Periodic Maintenance & Lubrication Chart



Sr. No.	Operation	Servicing	RECOMMENDED FREQUENCY							Subsequent
			1 <sup>st</sup> Free	2 <sup>nd</sup> Free	3 <sup>rd</sup> Free	Every				
			500 750	4500 5000	9500 10000	5000 Km after Previous Service				
29.	Handle bar control switches contacts cleaning	C,CL	C,CL	C,CL	C,CL	C,CL	C,CL	C,CL	C,CL	Use WD40 spray
30.	Steering play	C,A	C,A	C,A	C,A	C,A	C,A	C,A	C,A	
31.	Steering stem bearing*** & Cap steering bearing (Plastic)**	C,CL,L,R			C,CL, L,R		C,CL, L,R		C,CL, L,R	Check & replace if Damaged. Use HP Lithon RR3 grease for lubrication.
32.	Main stand & side stand pin**	CL,L			CL,L		CL,L		CL,L	Use AP grease.
33.	Swing arm pivot pin (for non silent bush)**	L		L	L	L	L	L	L	
34.	All fasteners tightness	C,T	C,T	C,T	C,T	C,T	C,T	C,T	C,T	
35.	Engine foundation silent bushes**	C				C			C	
36.	General lubrication-Clutch lever, front brake lever, kick lever.	L	L	L	L	L	L	L	L	Use AP grease.
37.	Idle speed / CO%	C,A	C,A	C,A	C,A	C,A	C,A	C,A	C,A	

✓ Tick in the box  after replacing the periodic parts.

# Periodic Maintenance & Lubrication Chart



Sr. No.	Operation	RECOMMENDED FREQUENCY								Subsequent
		Servicing Kms	1 <sup>st</sup> Free	2 <sup>nd</sup> Free	3 <sup>rd</sup> Free	Every 5000 Km after Previous Service				
			500 750	4500 5000	9500 10000					
38.	Coolant level in expansion tank**	C,A	C,A	C,A	C,A	C,A	C,A	C,A	C,A	Use recommended 'Ready to use coolant'.
39.	Coolant hose damage/clamps/leakage**	C		C	C	C	C	C	C	
40.	Radiator fins**	C		C	C	C	C	C	C	
41.	Spoke tightening**-Front & Rear	C,T	C,T	C,T	C,T	C,T	C,T	C,T	C,T	
42.	Front fork dust seal & Rubber bellow	CL		CL	CL	CL	CL	CL	CL	
43.	SAI, EVAP hoses - Check functionality, leakage or any other damage**	C,R	C,R	C,R	C,R	C,R	C,R	C,R	C,R	Replace if cut / damaged
44.	EVAP drain tube cleaning**	CL	CL	CL	CL	CL	CL	CL	CL	

✓ Tick in the box  after replacing the periodic parts.

\*\* As applicable to model

\*\*\* More frequent cleaning may be required while driving in dusty environment.

**C : Check, A : Adjust, CL : Clean, R : Replace, T : Tighten, L : Lubricate**

**Note :** Periodic parts, Oil, Coolant, Filters, All types of greases, Cleaning agents, Cables, Wear & tear parts, Rubber 'O' rings / oil seals / pipes, Gaskets to be replaced as per Periodic Maintenance and Lubrication Chart are mandatory and the same are chargeable to customer.



Non-use maintenance is necessary if a vehicle remains off road for a longer duration (more than 15 days\*\*). The correct and careful non-use maintenance carried out before storing the vehicle will prevent the vehicle from rusting and from such other non-operational damages like fire hazards.

- Clean the entire vehicle thoroughly.
- Empty the fuel from the fuel tank and carburettor float bowl (if fuel is left in for a longer time, the fuel will break and gummy substance could clog the carburettor).
- Remove spark plug & put several drops of engine oil into the cylinder. Crank the engine over slowly a few times to coat cylinder wall with oil & install back spark plug.
- Set the vehicle on a box or a stand so that both wheels are raised off the ground.
- Spray oil on all unpainted metal surfaces to prevent rusting. Avoid getting oil on rubber parts or brake liners.
- Cover entire vehicle neatly. Make sure that storage area is well ventilated & free from any source of flames or spark.
- Fill 10% excess air pressure in both wheels.

- Do not apply oil on front brake disc, to prevent rusting. If the front brake disc rusts during storage, do not attempt to clean it with soap water. The rust will go off automatically during first few application of brake.

### **\*\* For Battery :**

- a. Remove battery and keep it on wooden plank, in properly ventilated area.
- b. Before taking the vehicle for use.
  - Get the battery recharged from the Authorised Service Center / Battery Dealer.
  - Apply petroleum jelly on terminals. (applicable to certain models).

### **Preparation for regular use after storage :**

- Clean the vehicle
- Make sure the spark plug is tight.
- Fill the fuel tank with fuel.
- Change the engine oil.
- Check all the points listed in the Daily Safety Checks section.
- Check and inflate tyres to proper tyre pressure.





Bajaj Auto Limited gives the following warranty in respect of the “**Pulsar 220 DTS-i**” motorcycle manufactured by them.

Every possible care and precaution has been taken to ensure quality in respect of the material & workmanship in the vehicles manufactured by us. Bajaj Auto Limited will repair or replace at their Authorised Workshops, free of charge, part or parts there of as may be found, on examination, to have manufacturing defect within a period of 2 Years or 30,000 Kms., whichever occurs earlier from the date of sale subject to fulfillment of condition stipulated in part A, B & C given here under

**Warranty is applicable for only first owner of vehicle.**

### **Part A:**

Warranty claims in respect of such items like shock absorbers, speedometers etc. though claimed through us, are subject to acceptance of the respective manufacturers. In all such cases the decision of the respective manufacturer will be final and binding.

Proprietary parts like tyres, tubes, battery and spark plugs are warranted by their respective manufacturers (Only one year warranty from the date of purchase/as applicable) and should be claimed on them directly by the customer. Bajaj Auto Limited shall not be Liable to replace them

though their dealer will give full assistance in preferring such claims.

Bajaj Auto Limited undertake no liability in the matter of consequential loss or damage caused due to the failure of the parts. Delay, if any, at the repairing workshop in carrying out repair to vehicle shall not be a ground for extending the warranty period, nor shall it give any right to the customer for claiming any compensation for damages.

Bajaj Auto Limited reserves the right either to repair or replace the defective parts.

Where a defective part can be replaced by part/s of alternative brand/s, which are normally used by Bajaj Auto Limited in the course of manufacture, Bajaj Auto Limited reserves the right to carry out the replacement by a part or parts of any such alternative brand/s.

This warranty and any claim arising there from is subject to Pune jurisdiction only.

### **Part B:**

No claim for exchange or repair can be considered unless the customer :

- a. Ensures that immediately upon detection of the defect, he approaches any nearest Authorised Bajaj Vehicle Dealers & Recommended Authorised Service Centers with the concerned vehicle and enables him

## Warranty : Scope & Limit

**pulsar** DTS-i  
220

to remove and despatch the part / parts attributing to the manufacturing defect to the Company.

- b. Produces the Owner's Manual, in original, to enable that dealer to verify the details.

It must be expressly understood that claims forwarded directly to us by the owner / customers will not be entertained at all and such defective part/parts thus forwarded by them will lie at our factory at their own risk, and this warranty shall not be enforceable.

### **To avail benefits of warranty, following are mandatory**

1. Availing of Initial 3 Free Services without lapse.
2. Availing 4 paid services at every 5000 kms. or 120 days whichever occurs first without any lapse.
3. Availing of all above services at the Authorised Vehicle Dealers & Recommended Authorised Service Centers.
4. Maintaining all service records duly signed and stamped by dealers.
5. Usage of only recommended engine oil "Bajaj DTS-i 10000" at specified frequency for drain interval of 10,000 kms. & engine oil level top-up at 5000 kms.
6. Replacing mandatory periodic parts such as air filter, oil filter etc. as per periodic maintenance schedule.

### **Part C :**

Further this warranty is NOT applicable to :

1. Normal maintenance operations like brake & clutch adjustments, cleaning of fuel system, engine tune-up or such other adjustments.
2. Parts subjected to normal wear & tear like Clutch Plates, Brake Shoes, Chain, Sprockets, Fork Oil Seal, Spark Plug, Control Cables, Brake Pads.
3. Replacement of electrical items like self-start's wear and tear items (if fitted), bulbs & rubber components like grommets, 'O' rings, bellows as well as filters, packings, gaskets, fasteners etc.
4. Painted parts. Only blistering or peeling off of paint film are covered under warranty. Any defect arising out of external damages or due to usage of protective covers /additional protective coatings adverse atmospheric condition etc. is not allow like under warranty.
5. All consumables like Engine oil, Fork oil, Brake Oil, Grease etc. are chargeable to customer.
6. Any defect arising due to above consumables not changed as per scheduled or if used other than the recommended one.

7. All chrome plated parts are prone to rust or corrosion in coastal area or in acidic environment or due to neglected cleaning etc. However chrome film peeling is covered under warranty in general atmospheric conditions. Blue/ Yellow colouration of silencer near exhaust port is permissible and hence not covered under warranty.
8. Oxidation of unpainted/painted crankcase, cylinder block, cylinder head etc. in acidic environment or in a coastal area.
9. Valve lapping (De-carbonizing) is to be carried out if required.
10. Parts of the vehicle that have been subjected to misuse, accident, negligent treatment OR which have been used in conjunction with parts & an equipment not manufactured or recommended for use by Bajaj Auto Limited, if in the sole judgement of Bajaj Auto Limited, such use prematurely affects the performance and reliability of the vehicle.
11. Parts of the vehicle that have been altered and modified or replaced in unauthorized manner like use of wider tyres, loud silencers etc and which in the sole judgement of the Bajaj Auto Limited affects its performance and reliability.
12. **Vehicles which are not being serviced at recommended dealers as per the service schedule described or which have not been operated or maintained in accordance with the instructions maintained in the Owner's Manual.**
13. Vehicles used for any competition or race and/or for attempting to set up any kind of record.
14. Any failure arising due to use of adulterated or bad quality fuel.  
Parts affected due to bad fuel quality are not covered Under warranty.
15. If additional electrical accessories such as - Remote, Bigger horn, Musical brake light etc. fitted on vehicle.
16. If the vehicle has been used for commercial purpose like Taxi or any other means of commercial transportation.  
  
Bajaj Auto Limited reserves the right to make any changes in design or to add any improvements on the vehicle at any time without incurring any obligation to install the same on a vehicle previously supplied and sold. Also, the conditions of this warranty are subject to alteration without any notice.  
  
This warranty is the entire written warranty given by Bajaj Auto Limited for “**Pulsar 220 DTS-i**” motorcycle’ and no other dealer or its or his agent or employee is authorised to extend or enlarge this warranty.

# BATTERY WARRANTY CARD

MAKE OF BATTERY : .....

MFG. CODE OF BATTERY :

SR.NO.:

TYPE OF BATTERY : .....

DATE OF SALE : .....

NAME OF OWNER AND ADDRESS : .....

TYPE OF VEHICLE : ..... REG. NO.: .....

FRAME NO.: ..... ENGINE NO.: .....

## ***SERVICE RECORD***

Sr. No.	Date	Age Mths.	Specific Gravity	Voltage	Remarks	Dealer's Stamp & Signature	* Code
1							
2							
3							
4							
5							
6							

### **\* Code For Remarks:**

- LL** : Low electrolyte level.
- AE** : Electrical system needs attention.
- IR** : Insufficient running of vehicle.
- CB** : Cover broken.
- BC** : Broken Container.
- PM** : Poor maintenance.
- BA** : Battery abused.

Note : Customer should insist that "Service Record" must be filled by respective authorised battery dealer as proof of specified maintenance for easy settlement of claim, if any.

## TO BE FILLED IN BY BATTERY DEALERS / DISTRIBUTORS IN CASE OF CLAIM

Name of Dealer & Code : \_\_\_\_\_

Date of claim : \_\_\_\_\_ Battery Type : \_\_\_\_\_

Serial No. : \_\_\_\_\_ Date of Fitment : \_\_\_\_\_

Failure Mode (Please tick as applicable)

- |                        |                                     |
|------------------------|-------------------------------------|
| • Loose connection     | • Overcharge / Undercharge          |
| • Internal Short       | • Reverse Charge                    |
| • Plate Shedding       | • High Specific Gravity Electrolyte |
| • Intercell Connection | • Electrolyte Contamination         |
| • Does not Hold Charge | • Electrolyte Level not Maintained  |
| • Wrong Assembly       | • Left Lying Idle                   |
| • Wrong Application    |                                     |
| • Terminal Corroded    |                                     |

# Claim Accepted

## Claim Rejected

Details of Repair, if any \_\_\_\_\_

Note:

Please contact nearest respective authorised battery dealer for details immediately after purchase of vehicle.

---